

PRODUCT NOTES:

THESE ARE THE STANDARD GEOPANEL CONFIGURATIONS. CONTACT GEOMETRIK FOR INFORMATION REGARDING CUSTOM SIZES.

CUSTOM SIZES CAN BE UP TO 4'-0" WIDE X 8'-0" LONG.

TYPICAL STEPS FOR CUTTING PANELS:

1. MEASURE NON-FULL SQUARE DIMENSIONS DESIRED.
2. DETERMINE PANEL SIDE EDGE TO BE CUT.
3. SELECT PROFILE TO BE CUT.
4. CUT PANEL TO DESIRED WIDTH/ LENGTH.
5. RE-PROFILE NECESSARY GROOVES AS PER PRIOR TO CUTTING.
6. REPLACE EDGE BANDING TO MATCH.
7. REFINISH EDGE BANDING TO MATCH.

HOW TO READ PRODUCT "SKU" :

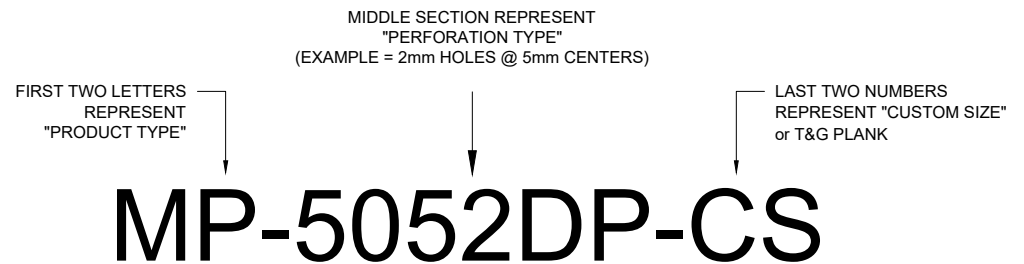

"SKU" ABBREVIATIONS:

MP = MICRO PERFO S
CS = CUSTOM SIZE
T&G = T&G PLANK
DP = DIAGONAL PATTERN



1449 Velocity St
Kelowna, BC, Canada
V1V 3C2

Description:
SKU INFORMATION

Product:
MICRO PERFO S

Sheet No:

MP 1.0

www.geometrik.com info@geometrik.com

Ph.(250) 769-1500 Fax.(250) 769-1520

Date: JAN 2018

Drawn By: MP

VENEER EDGE BANDING TO MATCH DECORATIVE FACE VENEER TYP.

DECORATIVE FACE VENEER WITH MICROPERFORATION

BALANCING VENEER ON BACK SIDE OF PANEL

HATCH INDICATES FACTORY APPLIED BLACK ACOUSTIC FABRIC TO BACK SIDE OF PANEL TYP.

MDF CORE BOARD

FINISHED SIDE OF PANEL

3/4"

STANDARD PANEL THICKNESS = 3/4"
*OPTIONAL THICKNESS AVAILABLE.

PRODUCT: MICROPERFO S

SKU#: MP-2052DP-CS

Geometrik

1449 Velocity St
Kelowna, BC, Canada
V1V 3C2

Description:

TYPICAL WOOD PANEL
CONSTRUCTION

Product:

MICROPERFO S

Sheet No:

MP 1.1

www.geometrik.com info@geometrik.com

Ph.(250) 769-1500 Fax.(250) 769-1520

Date:

JAN 2018

Drawn By:

MP

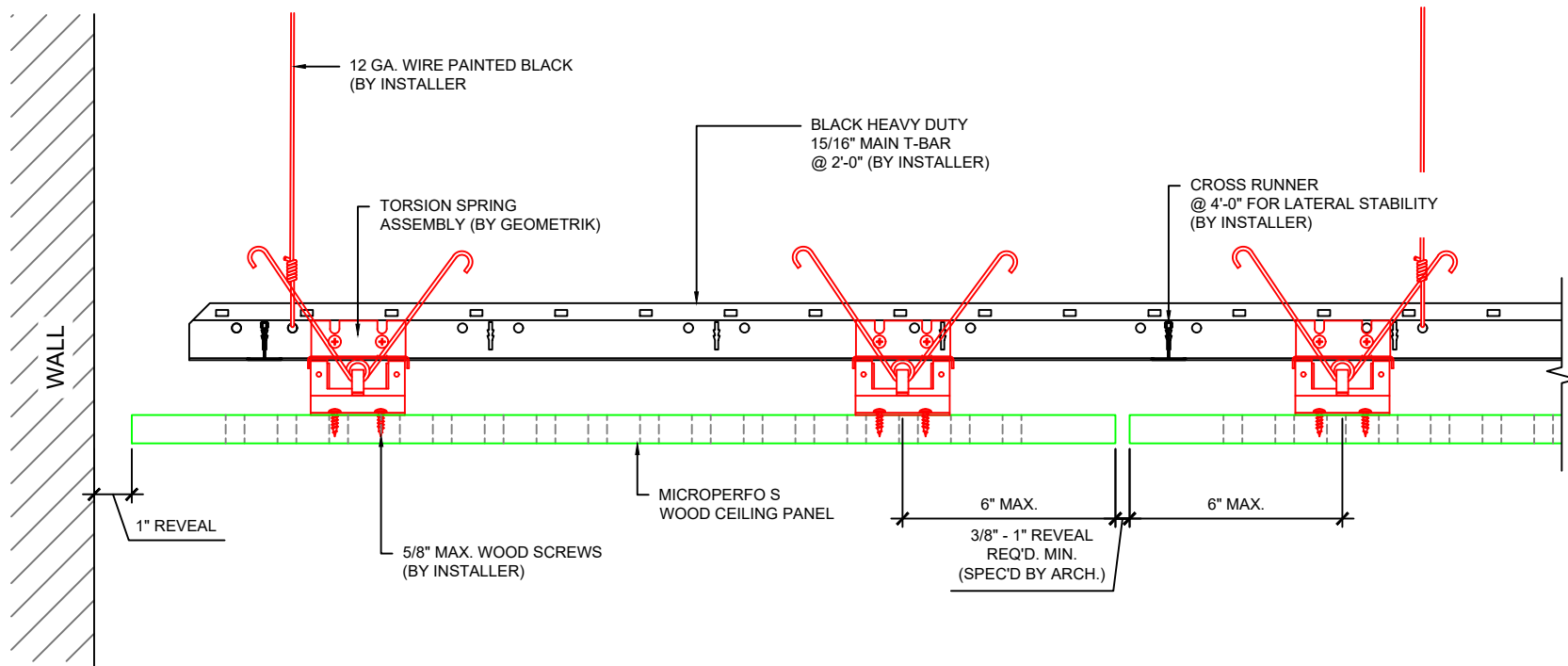

Geometrik

1449 Velocity St
Kelowna, BC, Canada
V1V 3C2

Description:

**TORSION SPRING
SUSPENSION SYSTEM**

Product:

MICRO PERFO S

Sheet No:

MP 2.0

www.geometrik.com info@geometrik.com

Ph.(250) 769-1500 Fax.(250) 769-1520

Date:

JAN 2018

Drawn By:

MP

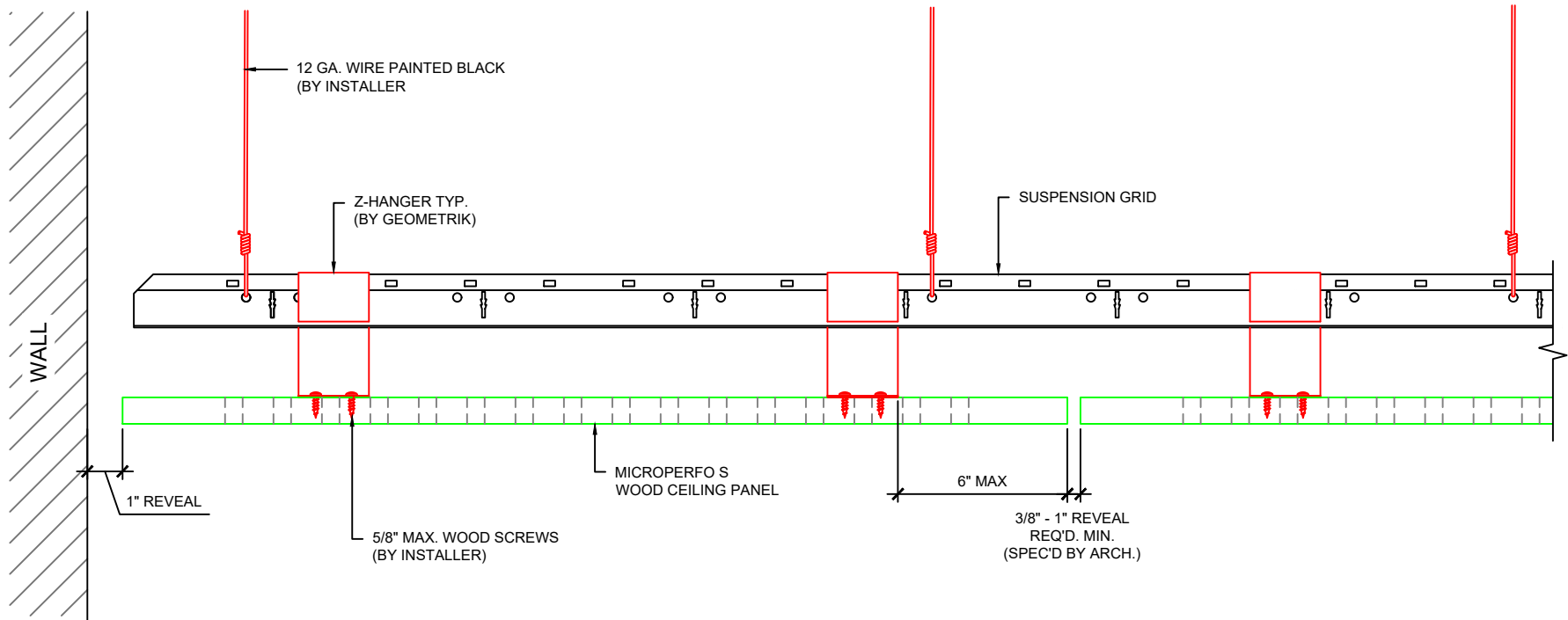

Geometrik

1449 Velocity St
Kelowna, BC, Canada
V1V 3C2

Ph.(250) 769-1500 Fax.(250) 769-1520

Description:
**Z-HANGER
SUSPENSION**

Product:
MICRO PERFO S

Date: JAN 2018

Drawn By: MP

Sheet No:

MP 2.1

www.geometrik.com info@geometrik.com

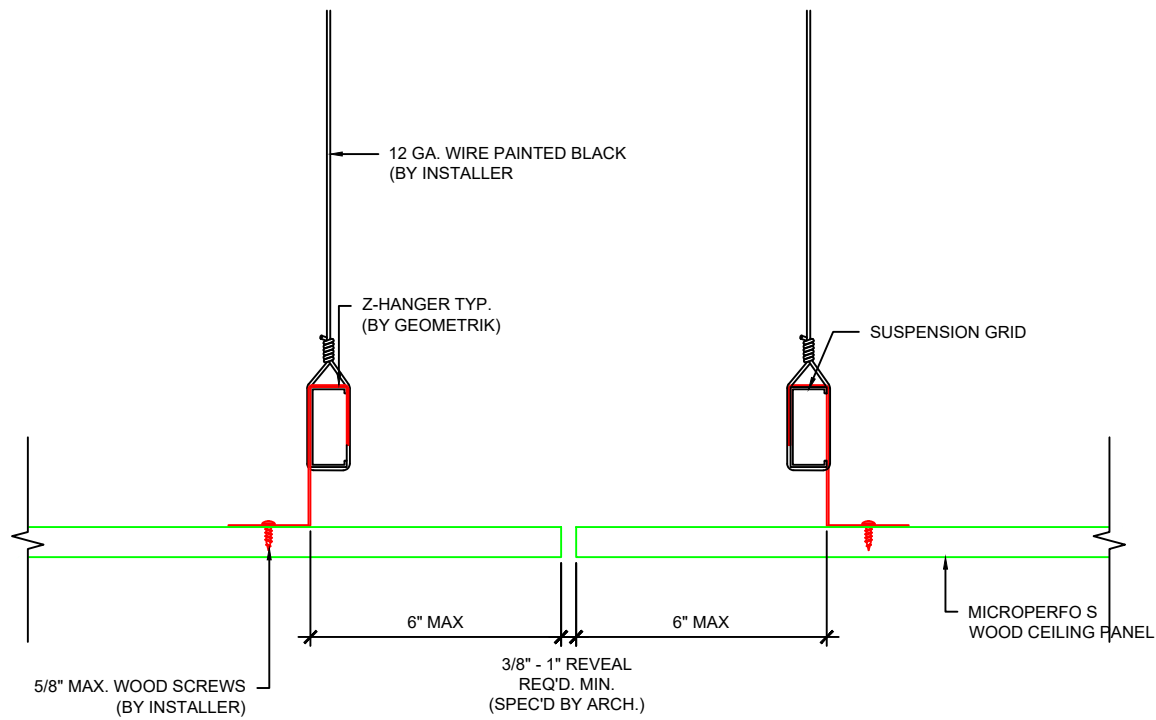

Geometrik

1449 Velocity St
Kelowna, BC, Canada
V1V 3C2

Ph.(250) 769-1500 Fax.(250) 769-1520

Description:

Z-HANGER
SUSPENSION SYSTEM

Product:

MICRO PERFOS

Date:

JAN 2018

Drawn By:

MP

Sheet No:

MP 2.2

www.geometrik.com info@geometrik.com

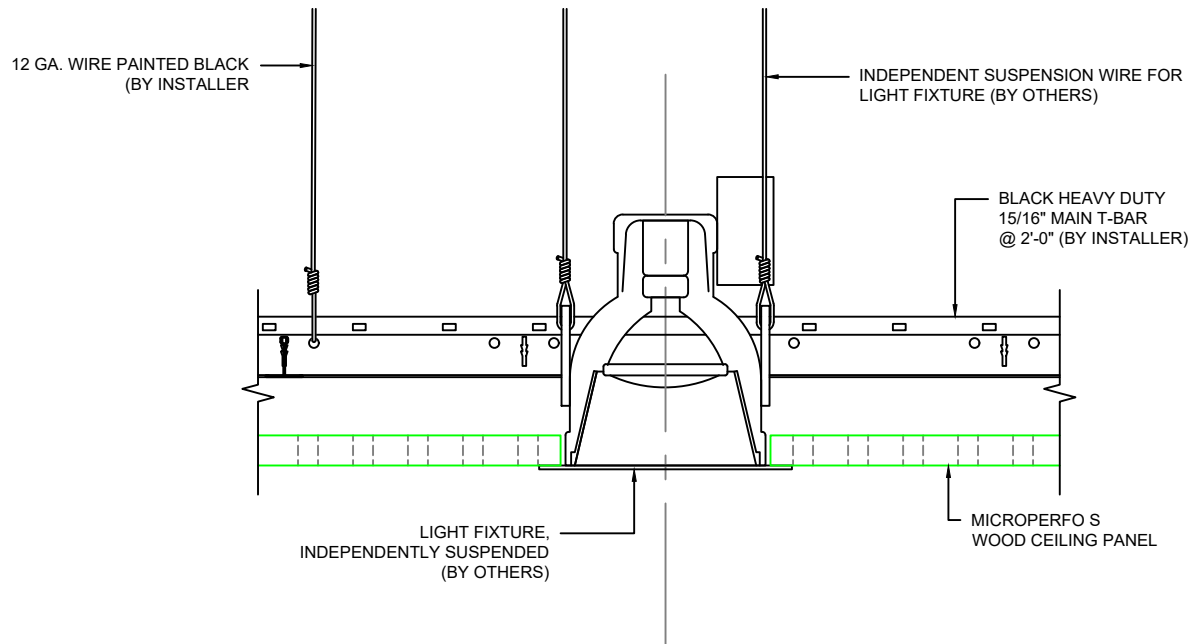

1449 Velocity St
 Kelowna, BC, Canada
 V1V 3C2

Ph.(250) 769-1500 Fax.(250) 769-1520

Description:
**POT LIGHT
 INSTALLATION**

Product:
MICRO PERFO S

Date: JAN 2018

Drawn By: MP

Sheet No:
MP 3.0

www.geometrik.com info@geometrik.com

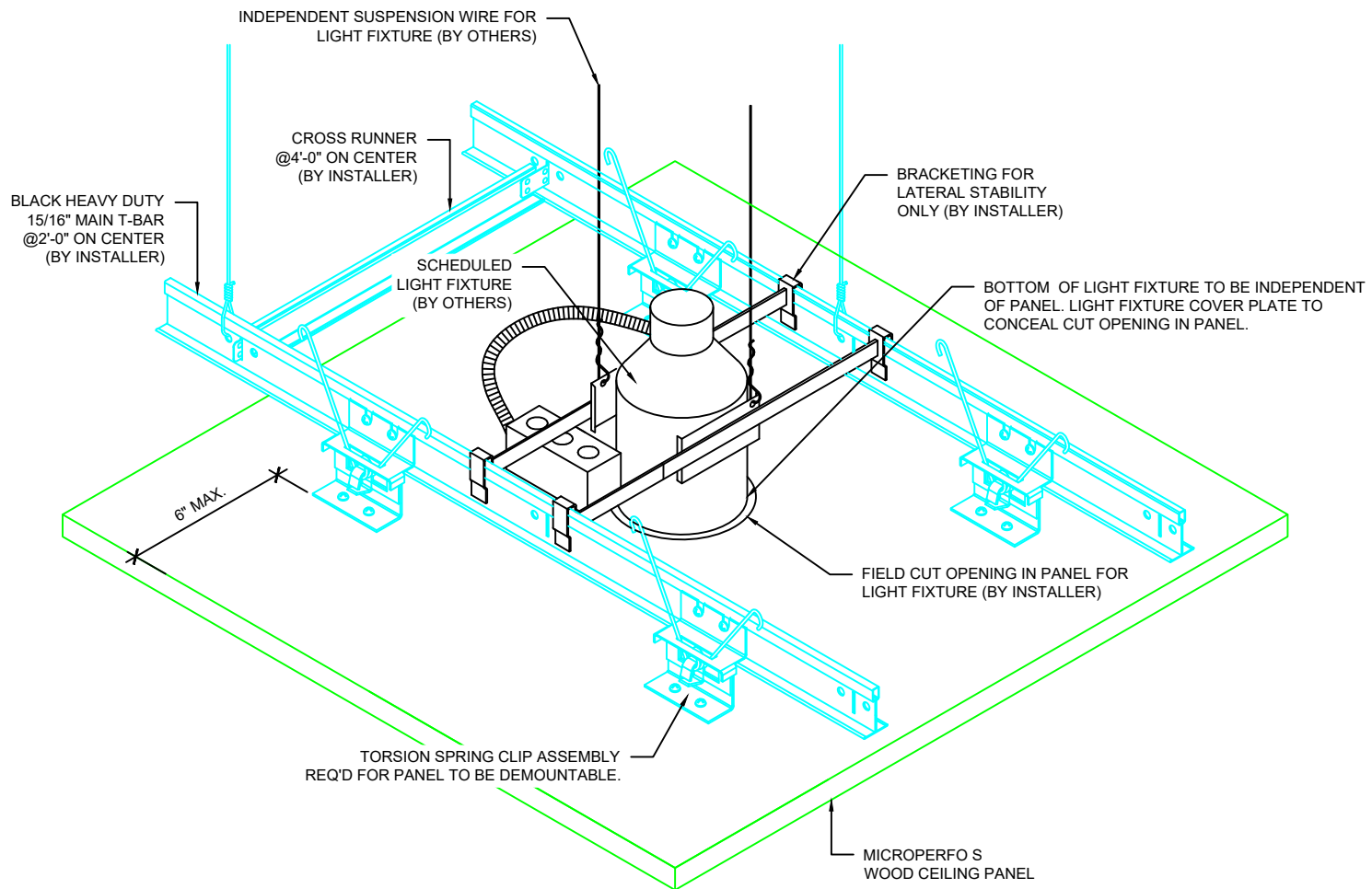

IMPORTANT:
 CUT PANELS MAY HANG
 UNSUPPORTED A MAXIMUM OF 6"
 FROM NEAREST T BAR CLIP.



1449 Velocity St
 Kelowna, BC, Canada
 V1V 3C2

Ph.(250) 769-1500 Fax.(250) 769-1520

Description:
**POTLIGHT
 CEILING INSTALL**

Product:
MICRO PERFO S

Date: JAN 2018

Drawn By: MP

Sheet No:

MP 3.1

www.geometrik.com info@geometrik.com

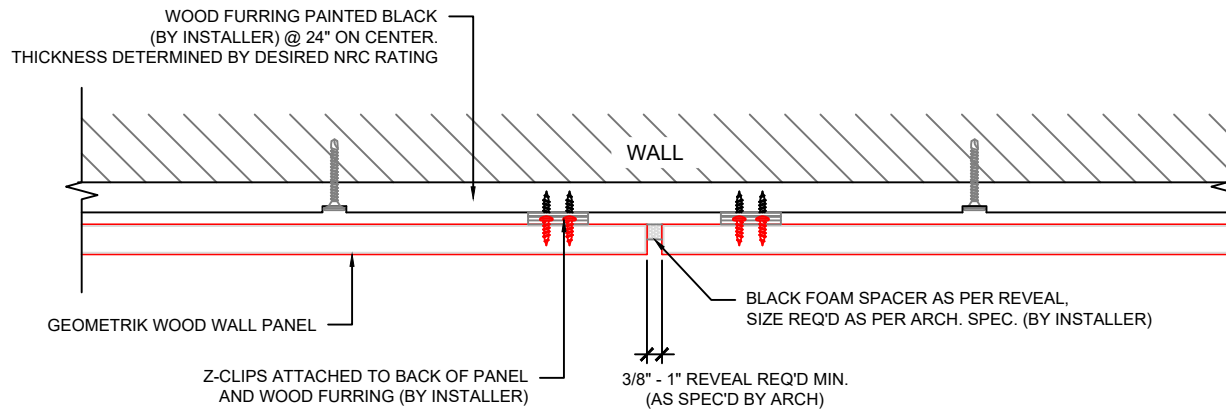

Geometrik

1449 Velocity St
Kelowna, BC, Canada
V1V 3C2

Ph.(250) 769-1500 Fax.(250) 769-1520

Description:

**WALL Z-CLIP
ATTACHMENT**

Product:

MICRO PERFO S

Date:

JAN 2018

Drawn By:

MP

Sheet No:

MP 4.0

www.geometrik.com info@geometrik.com

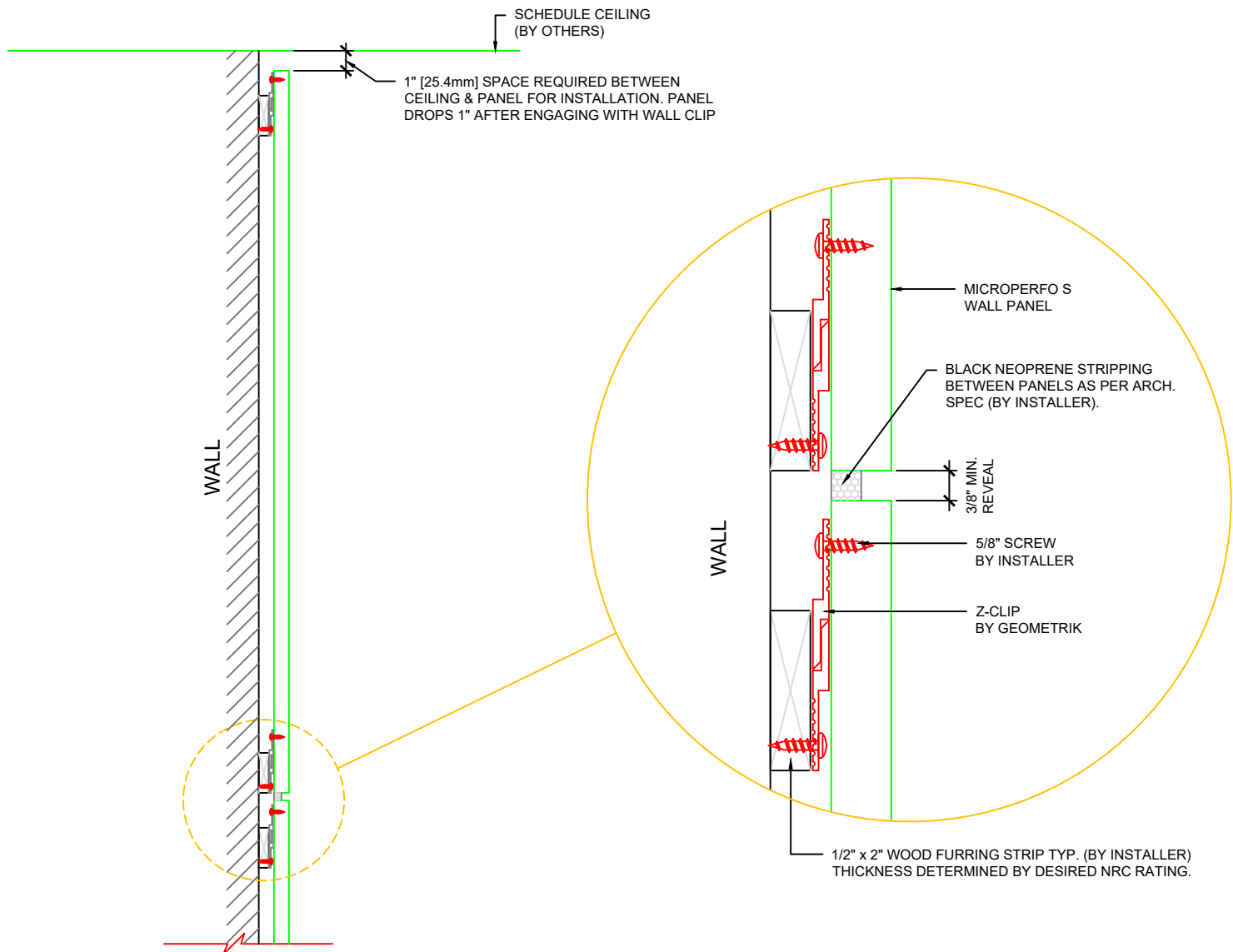

1449 Velocity St
Kelowna, BC, Canada
V1V 3C2

Description:
**Z-CLIP
ATTACHMENT DETAIL**

Product:
MICRO PERFO S

Sheet No:
MP 4.1

www.geometrik.com info@geometrik.com

Ph.(250) 769-1500 Fax.(250) 769-1520

Date: JAN 2018

Drawn By: MP